



Please consult the manufacturer's installation manual for all details and requirements before making a final design layout decision.

# Scion 55" Clean Face Linear Electric Fireplace

MODEL	WIDTH		HEIGHT		DEPTH		VIEWING AREA	BTUS
	Actual	Framing	Actual	Framing	Actual	Framing		
SF-SC55-BK	56-1/2" [1435]	57" [1448]	23-7/8" [606]	24-1/4" [616]	7-5/8" [194]	7-5/8" [194]	53-1/4" x 15" [1353 x 381]	5,000

LEFT SIDE

FRONT

RIGHT SIDE

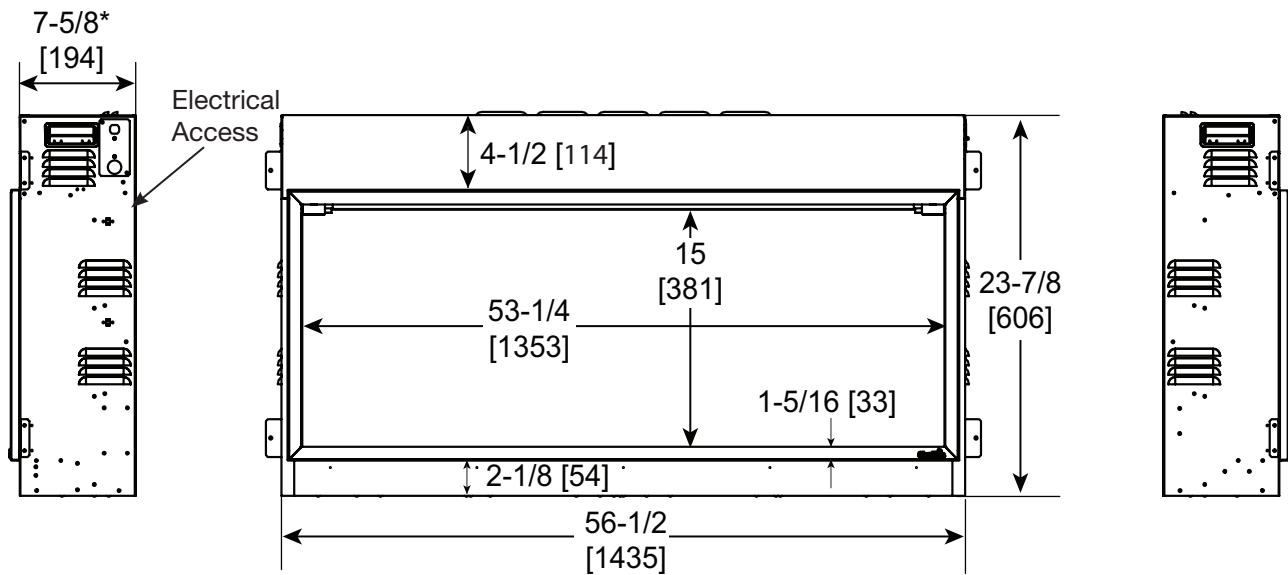

### ELECTRICAL CONNECTION REQUIREMENTS

CIRCUIT	CONNECTION METHOD	BTUS
15 AMP, 120V/60 Hz	Hardwire only	5,000

**MINIMUM CLEARANCES TO COMBUSTIBLES**

AREA	CLEARANCES
SIDES	0"
FLOOR	0"
TOP	0"
BACK	0"
FRONT	36" [914]

**FINISHING DIMENSIONS**

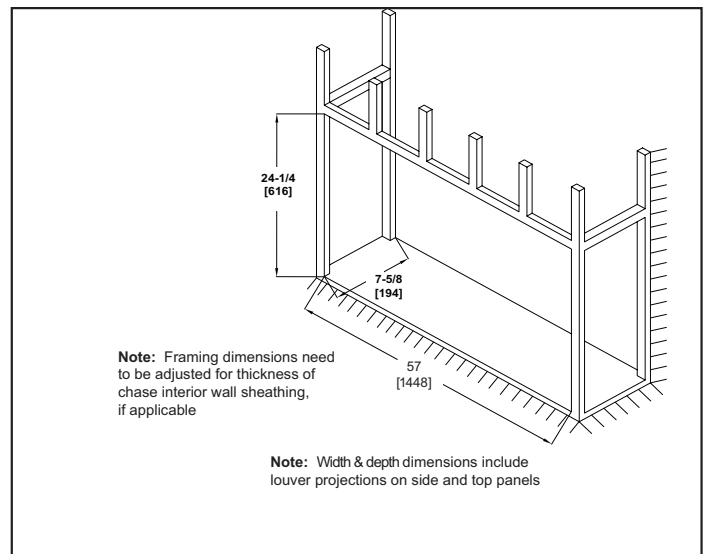

**MANTEL PROJECTIONS**

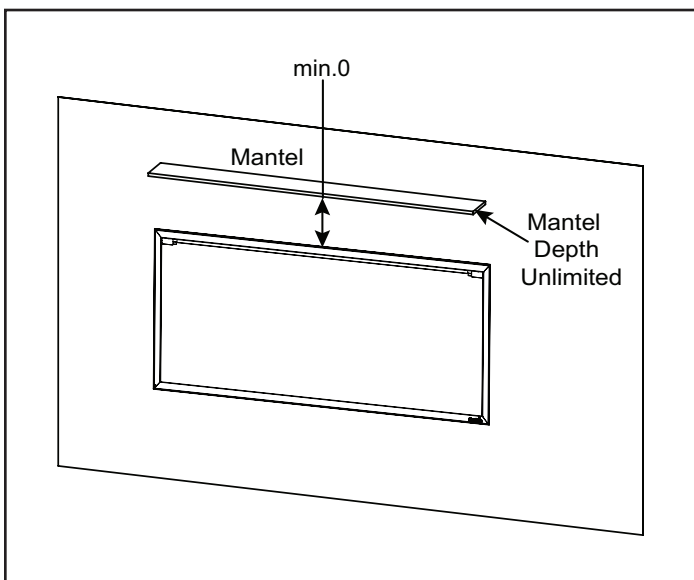

**APPLIANCE LOCATION**

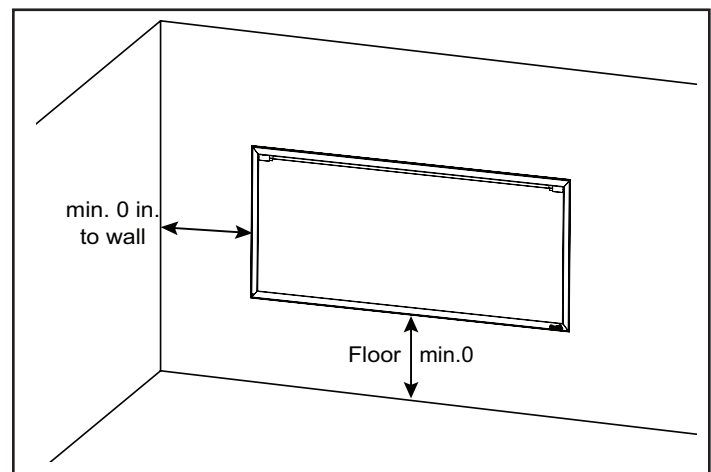

PRODUCT LISTING CODES	
US	CSA 22.2 No 46-M1988
INTERNATIONAL	CSA 22.2 No 46-M1988

Product information provided is not complete and is subject to change without notice. Product installation must adhere strictly to instructions accompanying product to avoid risk of fire and potential injury.